



Hematology

AEROSPRAY® HEMATOLOGY STAT Slide Stainer / Cytocentrifuge

Series 2



WORLD'S BEST STAINER IN PERFORMANCE AND RELIABILITY

AQUEOUS BASED

Automates the staining of blood smears and bone marrow samples to facilitate enhanced clarity and debris free slides using thiazin and eosin aqueous based staining techniques.

DO MORE IN LESS TIME WITH AEROSPRAY® STAT STAINING AND CYTOCENTRIFUGE TECHNOLOGY

- Superior staining process that is easy to use and saves time
- Rapid performance cycle time, slides are dried and ready for the microscope in minutes
- Cross-contamination is eliminated with a fresh application of stain
- Convenient automated waste level detection (optional)
- Superb cytocentrifuge, resulting in a five-to nine-fold increase in the number of cells on a slide¹ (optional)
- Seven peripheral blood and three bone marrow intensity settings
- Laboratory compliance with traceability features is ensured

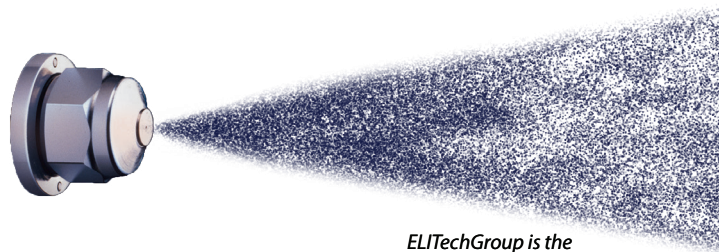

*ELITechGroup is the
inventor of Aerospray® Staining*

BENEFITS TO YOUR LAB

- Consistent, reliable, and standardized staining across multiple labs
- Easily compare slides from different labs
- High-quality control ensuring no stain variability when moving from LOT to LOT
- Reduces labor costs and aids labs in lowering the cost per slide
- Low maintenance required – simple and time efficient cleaning cycles
- The perfect back-up stainer that can be easily supplemented in any workflow in case of machine maintenance or failure

APPLICATIONS

- ▶ Bone Marrow
- ▶ Body Fluids
- ▶ Cerebrospinal Fluid
- ▶ Urine
- ▶ Washes
- ▶ Blood
- ▶ Sputum
- ▶ Aspirates
- ▶ Synovial

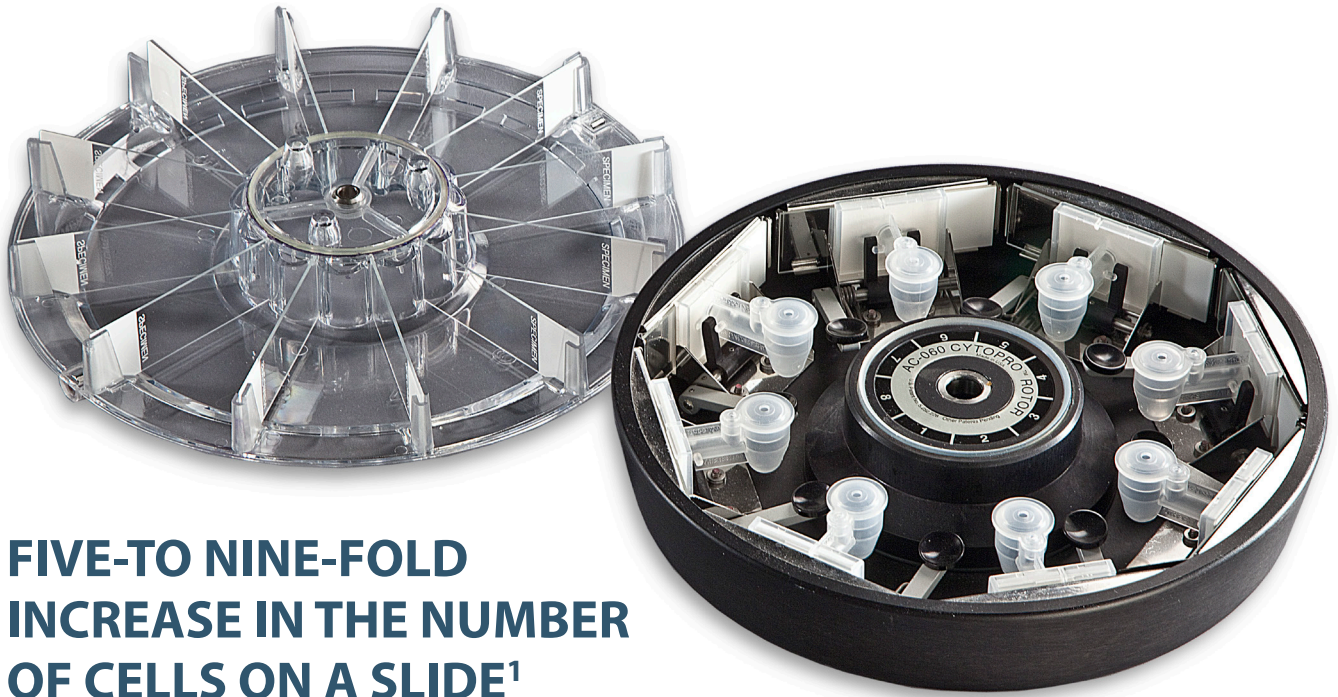

FIVE-TO NINE-FOLD INCREASE IN THE NUMBER OF CELLS ON A SLIDE¹

With the optional Cytopro® Rotor, the Aerospray Stainer becomes a superb cytocentrifuge with eight-slide capacity and programmability, at a fraction of the cost of purchasing a stand-alone cytocentrifuge.

AVAILABLE SAMPLE CHAMBERS

Patented flow control increases cell yield and delivers consistent results.

Standard Chamber

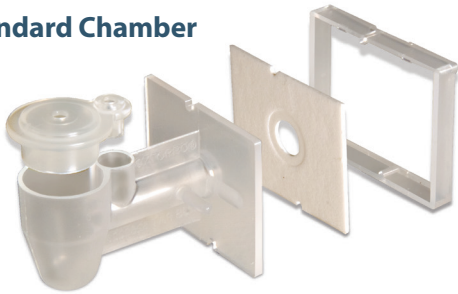

Combines ease of use with superb cell recovery.

Dual Chamber

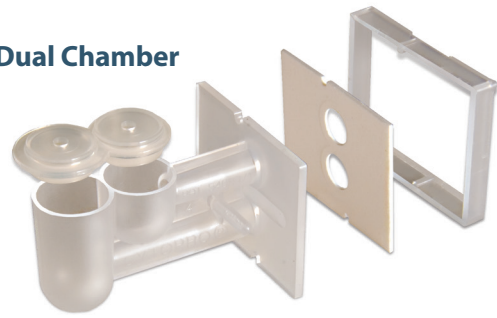

Places two samples on the same slide for increased efficiency and economy.

Cytopro Magnum®



Accepts sample sizes up to 6 mL.

¹ Huppmann, A. R., Rheingold, S. R., Bailey, L. C., Helfrich, M., & Choi, J. K. (2012). Detection of Leukemic Lymphoblasts in CSF Is Instrument-Dependent. *American Journal of Clinical Pathology*, 137(5), 795-799. doi:10.1309/ajcpp4hq2fxqezil

THE AEROSPRAY® PROCESS FOR HEMATOLOGY STAINING

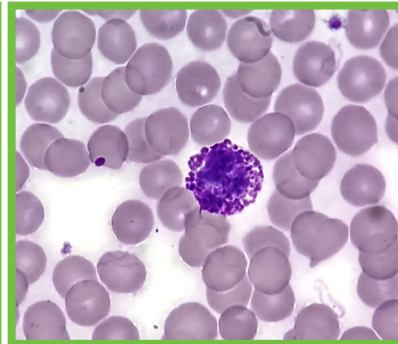

THE STAINING STEPS

1 Smears are automatically fixed with methanol or with Aerofix® fixative (alternatively, slides can be hand-fixed using methanol or Basofix™).

2 After a drying sequence, eosin stain is applied to stain acidophilic cell components, followed by a brief period for stain penetration.

3 Thiazin dye is then applied to stain the basophilic cell components, followed by another brief stain penetration period.

4 A buffered rinse cleans the slides of excess stain and is then removed by centrifugation.

 High speed, low duration spin creates dry slides, ready for the microscope in minutes!

BENEFITS OF THE ROMANOWSKY STAIN

■ RAPID STAINING KINETICS

- Blood smears are fixed, stained, and dried in approximately 4 minutes

■ IMPROVED STAIN STABILITY

- The slow rate of decomposition of thiazin and eosin dyes, in separate neutral aqueous solutions, allows a long shelf-life

- Staining results are highly reproducible and consistent

■ CLEAR FIELDS

- With virtually no stain precipitation or debris, slides are exceptionally clean

BENEFITS OF BASOFIX

With the use of aqueous stains, basophil granules may wash away. For those who prefer granulated basophils, ELITechGroup's Basofix fixative provides:

- Stain coloration more reminiscent of alcohol-based stains
- Fixation of basophil granules
- Strengthening of primary granules

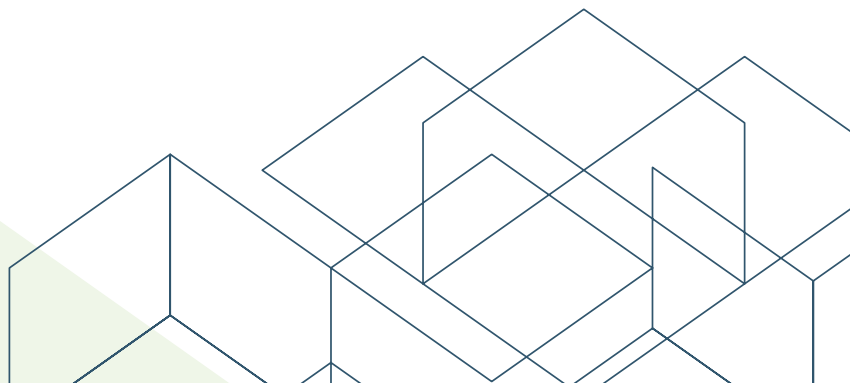

Aerospray® Hematology Stat Model 7122

Slide Carousel Capacity	1 to 12
Cytocentrifuge Rotor Speed	100-2000 rpm (± 5%), user programmable
Dimensions (W x H x D)	57 cm x 25 cm x 54 cm (22" x 10" x 21")
Clearance Height (lid open)	58 cm (23")
Weight	16.3 kg (35.9 lb)
Electrical Requirements	100 to 240 VAC (±10%) @ 50-60 Hz, 200 watts maximum
Drain Connection	Outlet on rear panel
Safety	Lid interlock: lid must be closed for operation, and is locked down during carousel rotation
Reagent Level Detect	Level detection on all reagent lines
Waste Level Detect	Level detection in waste bottle (optional)

Stain Consumption

Reagents	Theoretical Maximum Number Of Slides Per Bottle for a Full 12 Slide Carousel on Medium Dark Setting: #5	
	1 Clean Cycle/Daily	No Clean Cycle
Buffered Rinse 500 mL	792	996
Thiazin 500 mL	792	996
Eosin 500 mL	792	996
Fixative 500 mL	540	4200

Cytopro® Cytocentrifuge Rotor Model AC-160

Capacity	8 chambers and slides
Weight	1.1 kg (2.5 lb)
Dimensions (Dia. x H)	22.6 cm x 6.2 cm (8.9" x 2.4")

Catalog #	Description
MODEL 7122	Aerospray® Hematology Stat Slide Stainer/Cytocentrifuge
AC-160	Cytopro® Rotor
SS-029	Aerospray® Nozzle Cleaning Solution, 355mL
SS-029C	Aerospray® Nozzle Cleaning Solution Concentrate, 250mL
SS-035A	Hematology Stat Reagent A, Rinse, 500mL
SS-035/049B	Hematology Stat Reagent B, Thiazin Stain, 500mL
SS-035C	Hematology Stat Reagent C, Eosin Stain, 500mL
SS-048	Hematology Reagent D, Aerofix® Fixative, 500mL
SS-049A	Hematology Stat Reagent A, Basofix™ Rinse, 500mL
SS-049C	Hematology Stat Reagent C, Basofix™ Eosin Stain, 500mL
SS-049P	Hematology Stat Reagent P, Basofix™ Pre-dip Fixative, 500mL
SS-135/149A	Hematology Stat Reagent A, Rinse Concentrate, 135mL
SS-135/149B	Hematology Stat Reagent B, Thiazin Stain Concentrate, 135mL
SS-135/149C	Hematology Stat Reagent C, Eosin Stain Concentrate, 135mL
SS-135S	Hematology Stat Surfactant, 14mL
SS-148	Hematology Reagent D, Aerofix® Fixative Concentrate, 135mL
SS-149P	Hematology Stat Reagent P, Basofix™ Pre-dip Fixative Concentrate, 15mL
SS-MeOH	Aerospray® Reagent Grade Methanol, 500mL
AC-187	Barcode Scanner and Waste Level Detect Bundle
AC-188	12-Slide Carousel, Aerospray® Stainers

*Please check additions to catalog numbers made in your country

WORLD LEADER IN AEROSPRAY® STAINING TECHNOLOGY AND CYTOCENTRIFUGATION

50 YEARS

“Proven Performance, Time After Time.”

ELITechGroup has been in operation for nearly 50 years and distributes to over 100 countries. Proud to be the World Leader in Aerospray staining technology and Cytocentrifugation, offering the world’s most reliable solutions in performance and reliability. ELITechGroup is confident that this automated technology will elevate the performance of any laboratory and facilitate superior results.

Join the thousands of laboratories utilizing the world’s best staining technology and take your laboratory to a new level of efficiency and performance.



ELITechGroup has been certified by BSI to ISO 13485:2016 under certificate numbers MDSAP 689350 and FM 703046



WORLDWIDE OFFICES

Please contact your sales representative for terms, conditions and product availability in your country.

Headquarters

Australia
Belgium & Luxembourg
Brazil
France
Italy
New Zealand

+33 1 41 45 07 10

T: +61 1800 815 098
T: +32 9 282 05 31
T: +55 27 3025 1415
T: +33 4 83 36 10 82
T: +39 02 48 40 35 42
T: +64 800 555 611

Serbia
Switzerland
The Netherlands
UK
United States

T: +381 11 2467119
T: +41 26 663 86 60
T: +31 313 430 500
T: +44 1442 869320
T: +1 435 752 6011



 **ELITechGroup**
EMPOWERING IVD
AEROSPRAYSTAINING.com
info@elitechgroup.com